

DADCO®

Delay Return System Installation and Maintenance Manual



STOP! READ BEFORE INSTALLATION

DADCO World Headquarters: 43850 Plymouth Oaks Blvd • Plymouth, MI • 48170
734.207.1100 • 800.DADCO.USA • www.dadco.net • fax 734.207.2222

Maintenance and Installation

Pg. 3	System Components
Pg. 4	Operations Overview
Pg. 5	Installation and Precautions
Pgs. 6-7	Operation Notes
Pgs. 8-9	Troubleshooting
Pg. 10	Filling
Pg. 11	Replacement Parts
Pg. 12	Service Tools
Pg. 13	Accumulator Parts List
Pg. 14	Air Bleed Assembly
Pgs. 15-16	Filling and Venting
Pgs. 17-19	SBE Optional Accessory

General Operating Specifications

Charging Medium*:	Nitrogen Gas	Maximum Velocity:	1 m/sec (39 inch/sec)
Maximum Charging Pressure:	125 bar (1800 psi)	System Oil:	ISO 32-68
Maximum Operating Temperature:	63°C (145°F)	<i>Specific operating conditions will be assigned per system.</i>	

*See page 12 for charging assembly information.



**The operating parameters of production rate, pressure and travel must not be exceeded.
Exceeding parameters will overheat the system.
DADCO's Engineering Department must approve any change in conditions from the
original design specification.**

System Components

The DRS is comprised of four main components: accumulators, hydraulic cylinders, nitrogen control panel with hose assembly and hydraulic hose and fittings (illustrated below). Additional accessories for spring-back elimination (SBE) and active cooling are available. The information in this manual is provided to assist with the installation and maintenance of your custom designed DRS. Please keep this manual and the original System Information Packet together with the DRS for reference while in use.

Patented Technology



Control Panel with Hose Assembly

Control panel is connected to the accumulator allowing for filling, draining and monitoring of the nitrogen gas pressure in the system.



Caution-Operation Die Plate

Includes all system operating specifications.

Hydraulic Cylinder
Cylinder is filled with hydraulic oil. When the rod is actuated by the press the oil flows to the accumulator.

Accumulator

Nitrogen gas-over-hydraulic oil accumulator converts nitrogen pressure to oil pressure.

Hydraulic Hose and Fittings
Highly durable hose and o-ring face seal fittings connect the hydraulic cylinder to the accumulator.

Quick Disconnects
Zero-leakage quick disconnects facilitate installation and service.

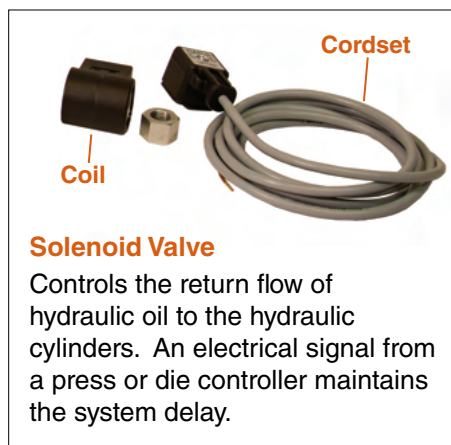

Solenoid Valve

Controls the return flow of hydraulic oil to the hydraulic cylinders. An electrical signal from a press or die controller maintains the system delay.

Spring-Back Eliminator (SBE)

An optional accessory is available for thin or fragile parts where zero force at the bottom of the stroke is required. This accessory is attached to the accumulator and will remove the typical 1-4% cylinder spring-back caused by entrained air and hose expansion.

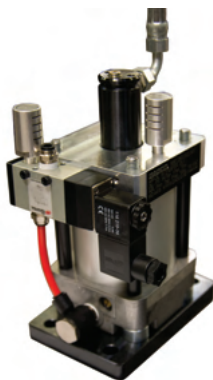

Active Cooling

Optional electric fan accessory is available for the accumulator to increase cooling capacity during operation. Other custom cooling solutions are available, contact DADCO.



1 Down Stroke: Part Forming

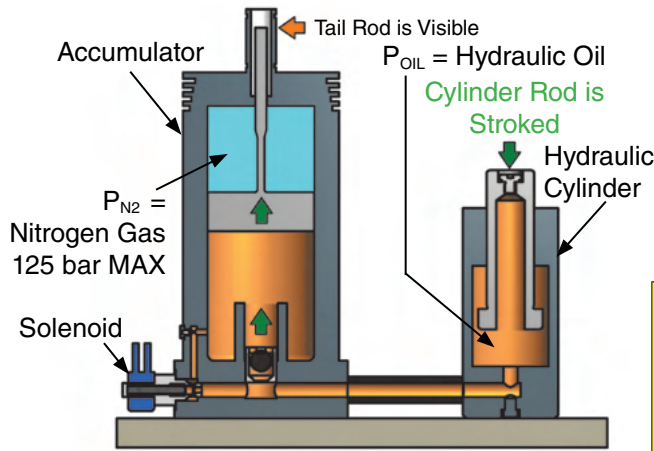

The accumulator is pressurized with nitrogen gas to energize the hydraulic oil to the pressure required for the forming application. The hydraulic cylinder and accumulator have equivalent pressure ($P_{N_2} = P_{OIL}$). During the downstroke of the die, the hydraulic cylinder delivers force like a typical nitrogen gas spring. The oil in the hydraulic cylinder is transferred through the accumulator's main check valve.

CAUTION: If tail rod is not visible this indicates the system is low on oil. Do not stroke the cylinder. Maintenance or service is required.

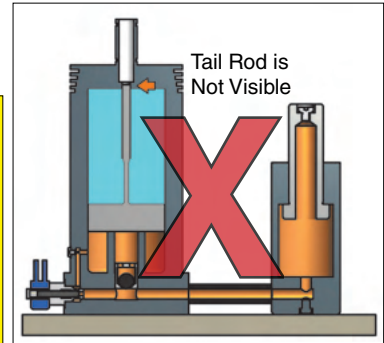

2 Bottom of Stroke: Part Complete

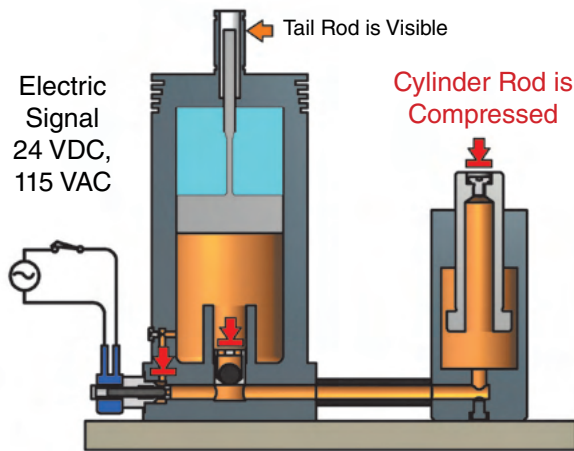

The solenoid valve is energized before the part is completely formed. The main check valve holds the pressurized oil in the accumulator. The hydraulic cylinder's rod will stay compressed as the press opens.

CAUTION: If the Tail Rod extends above the top mark, contacts or bends the yellow guard, stop operation immediately. This indicates the system has too much oil. Maintenance or service is required.

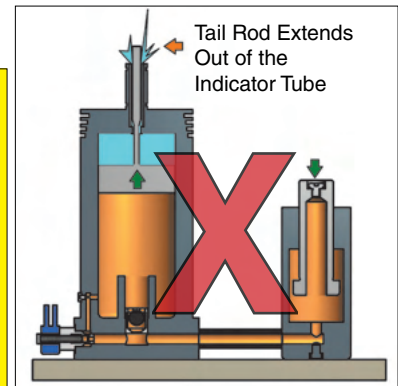

3 Return Stroke

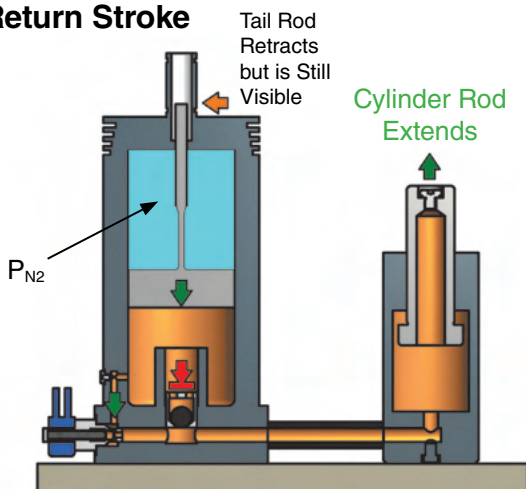

After the part is completed and the ram retracts, the solenoid valve is deactivated allowing the cylinder rod to extend at a controlled rate. During operation, the heat generated by the accumulator dissipates and the tail rod will retract into the indicator tube. An electrical fan or other options may be installed with the accumulator to facilitate cooling. **NOTE:** Increasing tonnage, production rates or travel of an existing system may require additional cooling components.

A 1-4% cylinder spring-back may occur during the delayed action. An optional Spring-Back Eliminator (SBE) accessory is available.

Installation and Precautions

⚠ For safe operation, read completely before operation and installation of the system components.

The AC.50 Accumulator and Delay Return cylinders are pre-filled and tested prior to shipping. No oil filling or bleeding is required if the system is installed properly. Components are typically shipped disconnected and must be reconnected for operation.

⚠ DO NOT COMPRESS CYLINDER ROD BEFORE CONNECTION TO ACCUMULATOR. If compressed before connection, cylinder and hose damage can result.



Operating Parameters

Custom caution-operation die plates are provided with each DRS. Plates have a custom laser mark indicating operation information per specific system design. Caution-operation die plates must be posted prominently on each tool near the accumulator or control panel. Specified operation parameters including production rate, nitrogen pressure and travel must not be exceeded; should parameters be exceeded damage, including over-heating may result. If a change from original design conditions is required, contact DADCO Engineering for a system consultation to determine compatibility.

Any increase in these factors will INCREASE running temperature:

- | | |
|-----------------------|----------------------------|
| Δ Ambient Temperature | Δ Pad Travel or Rod Travel |
| Δ Pressure | Δ Production Rate |
| Δ Cylinder Model Size | |

Conversely, a reduction in any combination of those conditions will LOWER the running temperature. Replacement caution-operation die plates can be custom ordered and alternate languages may be purchased on request. Contact DADCO for more information.

System Installation

Systems are 100% pre-verified in CAD to fit properly in the die shoe or custom mounting plate.

1. Install the hydraulic cylinders and accumulators into the stamping tool.
2. Securely fasten accumulators and hydraulic cylinders into the stamping tool.
3. Protect hydraulic cylinder and accumulators from potential damage during die handling/installation.
4. Accumulator locations should provide unobstructed access to the fill, gauge and electrical connections.
5. Cooling fan (optional), should facilitate a free path for air flow around fan intake and behind the accumulator.
6. Each hydraulic cylinder is provided with a single dedicated hose connection running to 1-6 available ports on the accumulator.

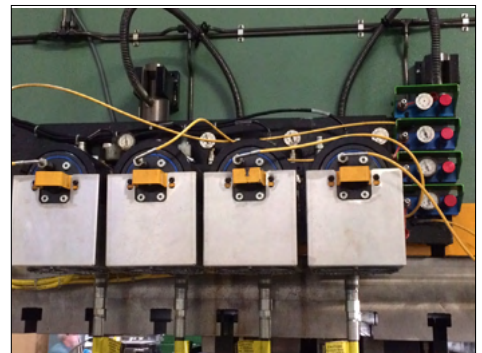

Couplings

A layout showing the hydraulic cylinder, accumulator and hose routing is included in the System Information Packet included with the DRS.

Most systems are provided with the drip-free hydraulic couplings on the hydraulic hoses. This allows hydraulic cylinders and accumulators to be connected and disconnected without changing the oil volume. Connection and disconnection must be done at ZERO or low pressure <200 psi (14 bar). Connection or removal at higher pressures is very difficult. The coupler has a safety locking sleeve ring that must be aligned before disconnecting. Rotate the ring to align the notch to disconnect.

⚠ DO NOT remove fittings or hose to avoid refilling and/or air bleed of the system.

Occasionally the hose is coupled at the hydraulic cylinder base. If couplings or hose lengths do not connect as designed on the layout, please contact DADCO immediately.

1. Connect each hydraulic cylinder hose assembly female coupling to the accumulator's male coupling.
2. Route hose according to layout provided through the die, securing as specified.

Electrical Solenoid

All accumulators are provided with a solenoid locking valve available with either 24VDC, 110VAC or 220VAC coils. The valve provides the hold down method when activated. Hydraulic oil will not be locked in the accumulator should the system or facility lose power. Hydraulic cylinders will return slowly.

Solenoid Current:
220 VAC -> 0.07 amps
110 VAC -> 0.13 amps
24 VDC -> 0.7 amps

An electrical circuit with signaling from the press or die must activate all accumulator valves' solenoids at the same time. DIN cable terminations or cables are provided. DADCO does not provide switches to activate the solenoid. System power and control should provide a provision for overload.

Electrical Cooling Fan

Systems are typically provided with cooling modules to allow for faster production rates. Fans are available with either 24VDC or 110VAC motors, specified at the time of quotation. Installation should not prevent air flow. The system power connection should provide a provision for overload.

Fan Cooling Current:
110 VAC fan 0.4 amp
24VDC fan 0.5 amp

Nitrogen connection: DADCO Y-500 or Y-700 hose, Y-400 with Surge Tank

Delay Return Systems have a maximum nitrogen charge pressure of 1800 psi (124 bar) at 20°C. Check the caution-operation die plate for operating pressure. The accumulator may be piped to a control panel or junction block via four ports in the top cap of the accumulator. For normal operation only one port is used, but all three may be connected to common systems. The system is supplied with a nitrogen hose and control panel. To change to a different port, switch the fitting with the plug in the alternate port.

The system must have a nitrogen charge to function. Gas pressure is read on the large control panel gauge. Oil will not be forced into the hydraulic cylinders if there is no gas in the system.

⚠ If the hydraulic cylinders are cycled without a charge, they will compress and not extend. If this happens in storage or die change, DO NOT add oil to extend the rods. Charge the system to force the oil back into the cylinders without loss of oil.

Operation

The operation parameters of production rate, pressure and travel must not be exceeded. Exceeding parameters will overheat the system. Running at a lower production rate, pressure and /or travel is acceptable. The system must be charged with nitrogen gas to operate. Delay Return Systems have a maximum nitrogen charge pressure of 1800 psi (124 bar) at 20°C. Check the caution-operation die plate for system specific operating pressure.

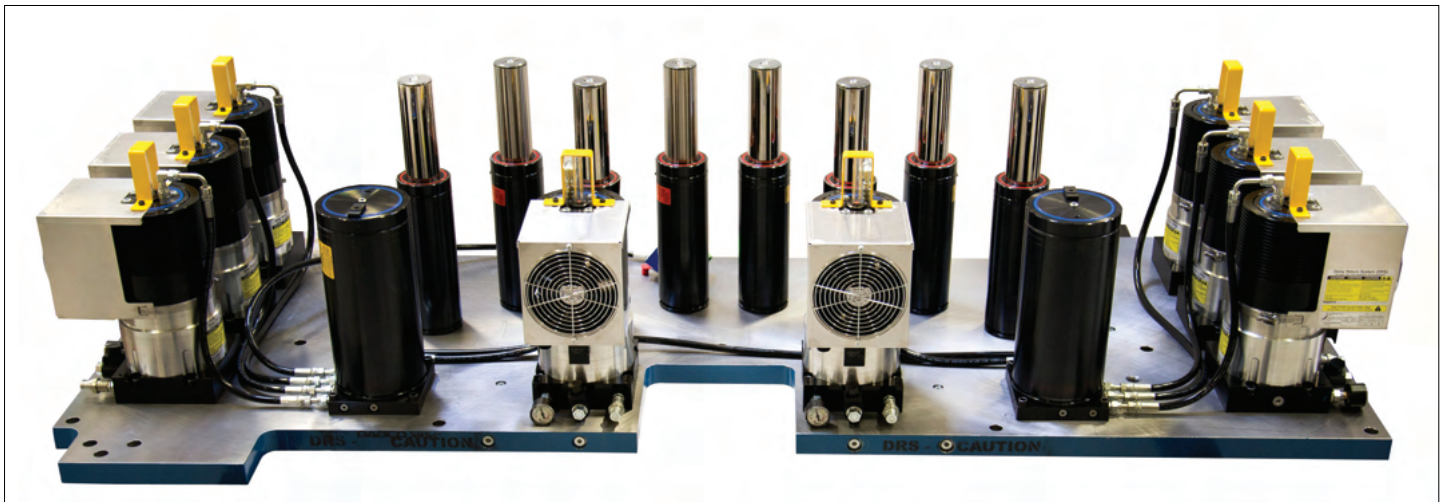

Hydraulic Oil System

Hose: 3000 psi (210 bar) high pressure reinforced hydraulic hose, (-6, -8, -10) DADCO Y-500 (-4).

Operating Temp: Recommended for operation at 145°F (63°C).

Oil Used: ISO 32-68

The pre-filled system consists of: hydraulic cylinders, hydraulic hoses, and lower half of the accumulator. The accumulator piston is filled to where the tail-rod is visible at the first mark of the indicator sight glass tube. Loss of oil or under filling may result in the hydraulic cylinders not extending fully. The accumulator is connected to the hydraulic cylinders with one quick disconnect hose per hydraulic cylinder. If the quick disconnects are functioning normally, disconnection should result in no fluid loss. This allows the hydraulic cylinders and accumulator to be positioned independently before the system is charged. See pages 15-16 for detailed service information.

Hydraulic System Notes

- To maintain air-free oil, use care when adjusting fittings and reconnecting quick connect hoses. This should be done at zero or low pressure only, <200 psi, (14 bar). For normal operation only the quick connects should be used. However, if fittings need to be rotated, minimize seal leakage by loosening seal-lok fittings with two wrenches, (keep port fitting torqued in place), by only 30°.
-  **DO NOT** cycle cylinders without the accumulator connected and charged. If they are cycled without flow for the oil, hydraulic cylinder or hose damage will occur.
- If the hydraulic cylinders are connected and cycled without nitrogen gas charge in the accumulator, the hydraulic cylinder rods will not extend again. The tail rod will move up in a properly filled system. Recharging after this will extend them once again. Rebleeding the system is not required.
- Maintain the static, non-cycled oil level to the lower sight line. If the tail rod is near the end of the guard, too much oil is in the system or too much oil has been displaced. When the Ram travels, the tail rod should not reach the upper sight line.
- If the tail rod is not visible, the system may be low on oil.
- If the tail rod is up, beyond the first mark of the indicator sight glass tube, hydraulic cylinder rods are also extended; there is too much oil or entrained air in the system. The accumulator will be damaged from over travel if cycled. Attach fill pump to remove excess oil and entrained air from system (pg. 9). If accumulator oil level cannot be set contact DADCO.

Oil System Pressure

Oil pressure can be read on the small gauge to the left of the solenoid valve. Oil pressure will read slightly less than the gas pressure when the system is not in use. When cycled, the pressure will increase as the nitrogen is compressed and the accumulator piston moves. When the hydraulic cylinders are cycled and held down by the solenoid valve, the pressure will read zero or a low figure depending on the weight of the die component.

-  When the valve is released or deactivated, the pressure will return to the static charging pressure. **During service ALWAYS disconnect solenoid and discharge nitrogen to verify that no potential energy is still in the accumulator.** The oil system pressure gauge does not show the oil pressure above the valve.

Loss of Oil or Entrained Air

The system is delivered pre-filled, air bled and tested for immediate use after nitrogen charge. Any loss of oil in the system must be replaced to allow full action of hydraulic cylinders. Air in the system may cause the hydraulic cylinders to "spring-back" slightly at the bottom of the stroke. Even small amounts of entrained air will eventually damage seals and cause extra heating. See Pages 9-10 & 14-16 for filling and bleeding air from system components.

Hydraulic Cylinder Spring Back / SBE Accessory

A small amount of spring back is unavoidable when the system is locked down. There are three causes of spring back: entrained air, the length and size of the hose and the compressibility of the fluid. Minimizing hose length is the first step in keeping spring back low. The majority of metal forming application functions requiring delayed action do not require elimination of spring back. If this is required, an air powered spring back elimination device is available. The SBE may be retrofit on most systems. See pages 17-19.



Pay careful attention to all safety warnings in the manual, on the product and posted caution-operation die plate. This system is a high pressure closed hydraulic system and should be de-energized before any service. To de-energize the system relieve all nitrogen pressure from the accumulator or system.

AC.50 Tail-Rod Sight Glass

The position of the rod in the sight glass indicates the position of the nitrogen/oil piston. When the pad or hydraulic cylinders are extended the rod should be at or below the lower mark. During pad travel the pin will extend between this mark and the maximum.

Tail-Rod Low - Below first line (cylinder rods up)

The system may still function in this condition. There is about 15 mm (.60") of travel that represents reserve oil in the system. If too low the pad will not extend completely. If there is no entrained air in the system, adding oil will set the rod correctly.

Tail-Rod Travel - (die closing, cylinder rods compressing)

The system is specified so the travel of the pin is about 50%-80% of the maximum. For an AC.50.24 this will typically be about 38 mm (1.5"). If the travel is greater there is most likely too much oil in the system. It is also possible that the cylinder travel has increased or larger volume hydraulic cylinders were added to the system.

Tail-Rod MAX - (BDC, cylinder rods down)

If the maximum line is exceeded the accumulator may discharge or be permanently damaged. Exceeding the max will cause the tail rod to vent nitrogen to remove energy from the system. If the travel continues, the tail rod will bend the yellow guard cover. In either case the system should be reviewed to prevent the over travel.

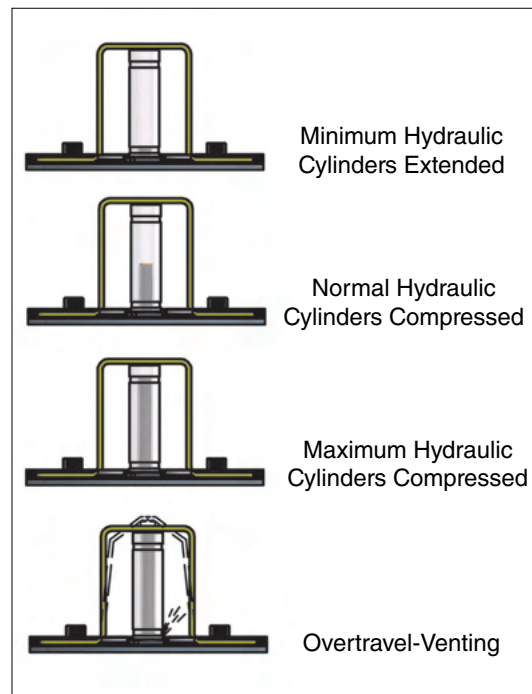

Overfilling

Overfilling can over extend the tail rod if care is not taken. When filling the systems, check the state of the hydraulic cylinders. If the rods are displaced then the oil will not show it's "static" position. It is better to fill with nitrogen charged at low pressure, <200 psi, (14 bar).

Pressure Gauge

The control panel shows the nitrogen pressure. The small gauge on the accumulator shows the hydraulic oil pressure in the hydraulic cylinders. It will drop to zero when the hydraulic cylinders are in the down position.

Couplers

Flush face couplers cannot be removed or reconnected unless the pressure is very low or zero. Turn the coupler sleeve to align the notch to allow disconnect.



Normal Operating Maintenance:

- System's seals may weep oil over time; the oil reserve in the accumulator will refill this small amount. When the tail rod is not visible at die open (hydraulic cylinder rods up) oil should be added.
- Add oil if there are no major leaks or damage.
- Charge system to low pressure <200 psi, (14 bar).
- Attach air-oil pumping system or hand pump.
- Pump oil to system until rod is at low level of sight glass.

Potential Component Concerns

- *Internal Piston Leak:* Contact DADCO for service
- *Hydraulic Cylinder Leak at Rod Seal or Cartridge:* Contact DADCO for service
- *Hydraulic Cylinder Leak from Auxiliary Port or Rupture Disk:* Contact DADCO for service
- *System Has Gas in the Oil:* Spring back: see page 14 for System Bleed Steps
- *Nitrogen Leaks:* Discharge system and replace leaking component, hose or fitting seal.
- *Oil Fitting, Gauge, Solenoid Leak:* Discharge nitrogen to zero. Leave valve open. Replace or service one fitting at a time. This prevents air from entering the system. Rebleeding the system or part of the system may be required.
- *Accumulator Front Head O-Ring Leak:* Please contact DADCO for service.
- *Accumulator Front Head Tail Rod Seal Leak:* Discharge nitrogen to zero. Leave valve open. Remove tail-rod guard. Remove tail rod tube. Remove tail-rod subassembly with socket wrench. Replace entire subassembly.
- *Connector Problem:* Coupler may need to be replaced. Discharge nitrogen to zero. Leave valve open. Remove coupler from thread ends.
- *Hydraulic Cylinder failure from Overpressure:* Discharge nitrogen to zero. Leave valve open. Please contact DADCO for service advice.

Electrical - Cooling

- **System Does Not Delay:** Check electrical connections and operation of coil. Replace coil or replace solenoid valve, this may require air bleeding on refill. Verify proper coil voltage. Contact DADCO for service advice.
- **System Overheating:** Check operation specifications on caution-operation die plate. Exceeding travel, pressure or production rate may cause overheating. Changed conditions of operation will change operating temperature. Check proper function of cooling fan and free flow of air if applicable.
- If ambient temperature exceeds 95°F (35°C) more or modified cooling may be required.

DRS System Air Bleed and Adding Oil to AC.50 Accumulator

1. See pages 10, 14-16 for more detail on system bleed setup.
2. Discharge system to zero.
3. Slowly open front M6 bleed port block with T20 drive.
4. Install bleed hose fitting AZ003399 into vent block.
5. Bleed hose is routed back to pump fill cap or to waste oil bucket.
6. Attach DADCO air-oil pump DRS.FPA6 to AC.50 front male coupler.
7. Depress pedal to add oil. Depress carry lever to relieve oil and pressure back to the pump.
8. Charge N2 system to 200psi(14bar)- this may eject some air and oil thru the bleed hose.
9. Once the AC.50 piston is down, flow should stop unless there are internal leaks.
10. Continue pumping oil into the system until oil runs free of bubbles.
11. Replace M6 bleed port plug
12. Depress pedal to add oil until tail rod moves into lower position.
13. Tail rod at lower mark gives a sufficient oil reserve for operation.
14. Disconnect pump and check all fittings and connections before nitrogen gas charge.
15. Charge nitrogen slowly to an intermediate pressure (ex. 500 psi/35 bar).
16. Monitor all connections for leaks and discontinue test if oil leaks occur.
17. If tail rod drops more than 3 mm (1/8") there may still be air entrained in oil.
18. Note: On systems with a long hose, tail rod drop may be significant during pressurization.
19. If tail rod position is OK the DRS system is ready to operate.

System Bleed at Hose and Hydraulic Cylinder

Fittings are available to fill and bleed the hydraulic cylinder and hose assembly separate from the accumulator. The main bleed G 1/8 port in the hydraulic cylinder is typically in the rod end, the hydraulic cylinder base or the side of the hydraulic cylinder. See page 15.

Service of Accumulators and Hydraulic Cylinders

The preferred method for internal service of the accumulator and the hydraulic cylinders is to return the system to DADCO. For larger systems or high production tools we recommend keeping an AC.50 spare on hand to swap in for continued production. See pages 11-13 for components that may easily be replaced and are available from DADCO.

Filling / Bleeding *Not required for newly delivered systems.*



DO NOT open or tamper with bleed ports at high pressure, >200psi, (14 bar). Accumulator must be discharged at the control panel for service.

Fill the system with the hydraulic cylinder rods extended and all hoses connected. If the hydraulic cylinder rods are depressed, the system will not have enough oil in it to function properly. DO NOT cycle the hydraulic cylinders if they are uncoupled from the accumulator. See the visual instruction for proper bleeding method, pages 15-16.

Accumulator - Oil Filling

The AC.50 Accumulator has a dripless quick connect dedicated to filling with an oil delivery or filling pump, (DRS. FPA6). The accumulator should be charged with low psi nitrogen, <200psi (14 bar), to position the piston down while the system is filled with oil and air is bled out. The filling hose kit, (AZ003399), provides a method for containment of the air and oil when returning to tank or waste container. Use caution when filling or bleeding the system. Contact DADCO for service equipment and further training.

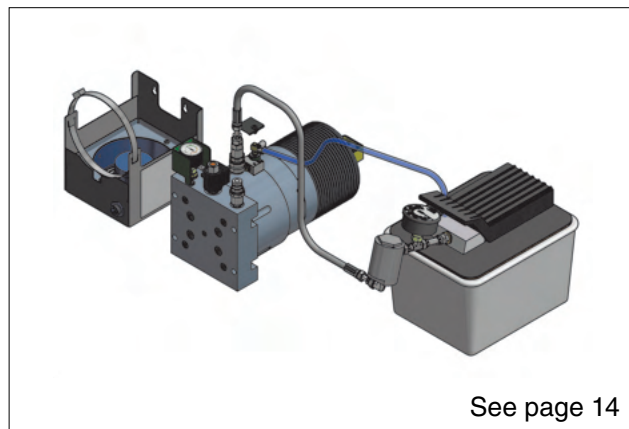

See page 14

Hydraulic Cylinders - Oil Filling

Delay Return System hydraulic cylinders are normally provided with a hose and female coupler or a male coupler. The hydraulic cylinder will have either a vented G1/8 (90.607.065) or M6 port plug in the rod end or a vented G1/8 or M6 air bleed port in the hydraulic cylinder base. These ports should be left open at initial filling. The filling hose kit provided facilitates pumping oil back to the tank or into a waste container and visually checking for air bubbles. Close all ports. When pressurizing the system verify the ports are properly torqued and do not leak. This is especially important for hydraulic cylinder rod end ports since they are inaccessible.

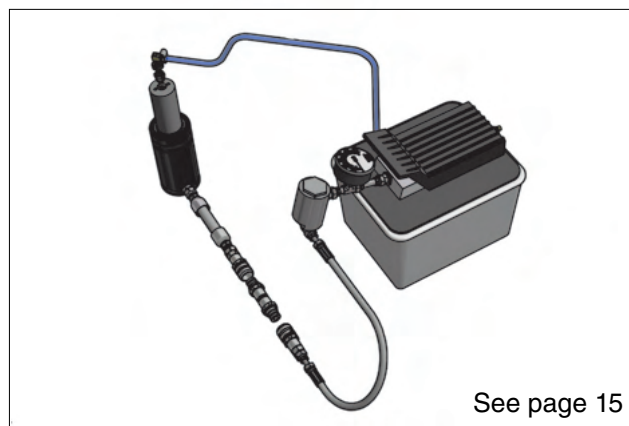

See page 15





Cycling hydraulic cylinders disconnected from AC.50 will damage the hydraulic cylinder, hose and fitting.

Note; service couplers for cylinder fittings, AZ001656/59/60, shown on page 12.

Replacement Parts

Below is a list of recommended system parts to stock for general maintenance. For internal service and refurbishment, please return to the factory for evaluation.

 Be sure to drain nitrogen from the system before performing any maintenance.



Indicator Guard A595M ____
(025, 050, 075)

Indicator Tube A585T ____
(025, 050, 075)

Indicator Tube Cartridge AZ003265





Nitrogen Gas Port Adapter 90.505.115

Liquid Filled Gauge DPG-3RL
Pressure Range: 0-450 bar (0-5000 psi)

Hydraulic Service Union

**Active Cooling Option
AC.50.CM.** ____
(115 VAC or D24 VDC)



Part Number	Components
SV08 Solenoid Cartridge: AZ511652	
Valve Solenoid, Coil only: AZ541354 – 24 VDC AZ541655 – 115 VAC	
Cordset with LED: AZ541614 – 24 VDC AZ541613 – 115 VAC	
Modular DIN Connector: AZ541653	

Service Tools

Oil Pump - DRS.FPA6

Air powered oil pump with 2 gallon plastic container used for filling and replacing system oil. Service union required for filling hydraulic cylinders.

Air Supply: 3-8 bar (40-150 psi)
Reservoir: 7.5 L (2 gallon)
Flow: 1.2 L/min (75 in³/min)
at 7 bar (100 psi)
inlet pressure



Air Bleed Tube and Fitting Kit - AZ003399

Used to bleed the air from the hydraulic oil in the system during filling. Includes 90.607.065 G 1/8 reducer.



Fittings, Flush Couplings & Hose Specifications

All hydraulic hose and fittings supplied are ORFS and use zero leakage flush couplings. Hydraulic hose and fittings are predetermined and designed based on the application requirements. Hose assemblies are custom per system and will ship as components of the DRS order. For more information on replacement hose, fittings or hose assemblies contact DADCO. To make your own hose assemblies you will need a crimper and dies; please contact DADCO.

Hose Size	Straight	Straight Reducer	Union	Plug	Female	Male	Service Union	Part Number	OD		ID		Bend Radius		
									inch	mm	inch	mm	inch	mm	
- 6	PF6F5OLO	PF4-6F5OLO	PF6F5OHAO	PF6HP5ON	AZ531657	AZ531656	6/6	AZ001656	PH451TC-6	.68"	17	.375"	10	2.50"	63
- 8	PF8F5OLO	PF6-8F5OLO	PF8F5OHAO	PF8HP5ON	AZ531658	AZ531659	6/8	AZ001659	PH451TC-8	.80"	20	.500"	12.5	3.50"	89
- 10	PF10F5OLO	PF8-10F5OLO	PF10F5OHAO	PF10HP5ON	AZ531661	AZ531660	6/10	AZ001660	PH451TC-10	.94"	24	.625"	16	4.00"	102

Quick Disconnect Charging Hardware 90.310.044

Use the DADCO Quick Disconnect Filling Assembly with self-venting capabilities to charge the accumulator, through the nitrogen control panel, with nitrogen gas as specified. Check the caution-operation die plate on the system for proper charging pressure.

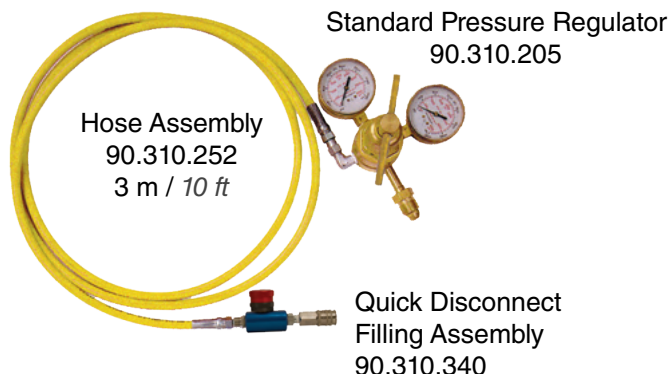

AC.50 Parts List

Number	Part ID	Description
1	AZ511653	AC.50 SOLENOID VALVE SVD08-21
2	AZ531656	DRS MALE-6 QUICK COUPLING
3	A507M050	AC.50 SLEEVE M025, M050, M075 07-7463
4	UMG08125008	AC.50 M8X8 CONE POINT SET SCREW
5	DPG-3RL	MINI CONTROL PANEL GAUGE ASSY
6	A585T050	AC.50 TAIL ROD TUBE T025,T050,T075 85-7803
7	90.505.110	G1/8 PORT PLUG ASSEMBLY
8	90.505.115	S-115 STRAIGHT ORFS
9	A59M050	TAIL ROD GAURD M025/M050/M075 95-7803
10	AZ003265	AC.50 TAIL ROD CARTRIDGE ASSEMBLY
11	AZ457803	O-RING 0.426 X 0.070 2-013 70duro
12	HC873530	90.405 COMPACT CONTROL PANEL GUARD
13	UMA06100016	M6 X 16 SHCS
14	PFHA06-6	PF COMPACT UNION 6-6
15	90.505.122	G1.4BSPP -> ORFS STRAIGHT
16	UMF0508012	M5 X 12 BUTTON HEAD CAP SCREW
17	UMA08125060	M8 X 60 SHCS
18	UMA10150050	M10 X 50 SHCS
19	90.607.110V	90.607.110V M6 PORT PLUG VENTED
20	AZ953336	AC.50 BASE BLEED BLOCK
21	UMF06100010	M6 X 10 BHCS
22	MZ451437	2-007 90A O-RING (0.144 x 0.070)
23	90.505.110V	G-109 FLUSH PLUG VENTED STYLE

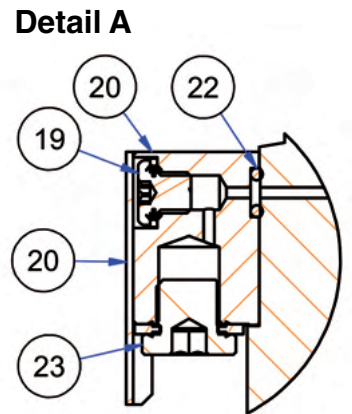
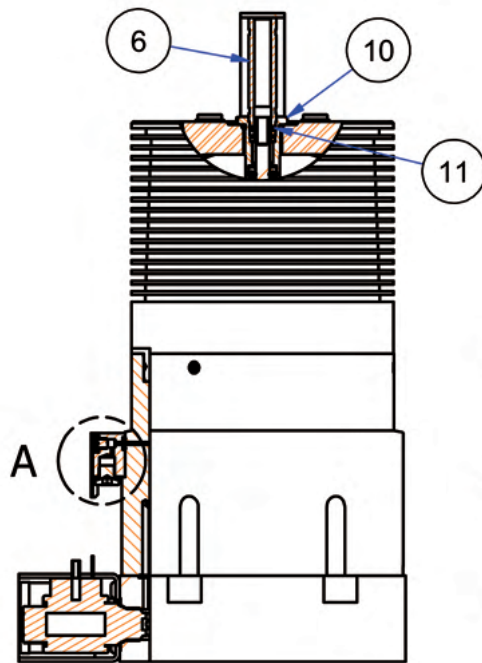
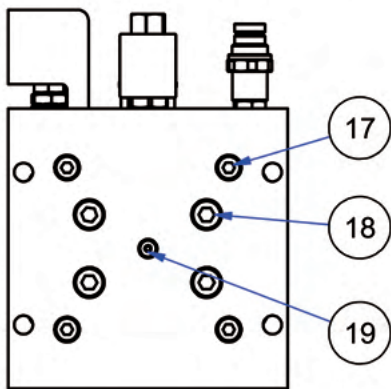
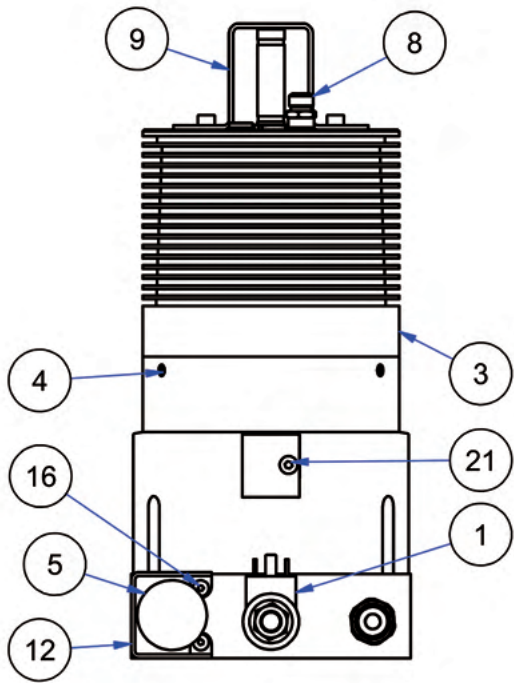
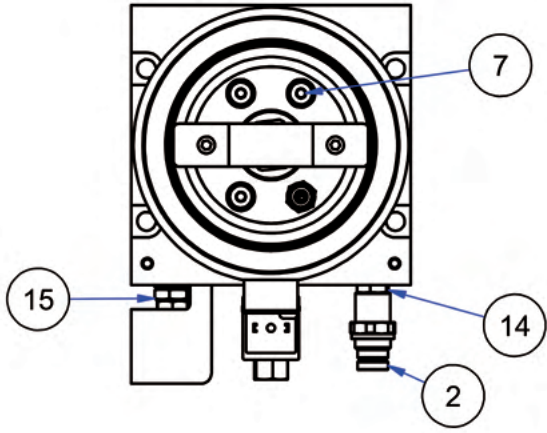

Air Bleed Assembly

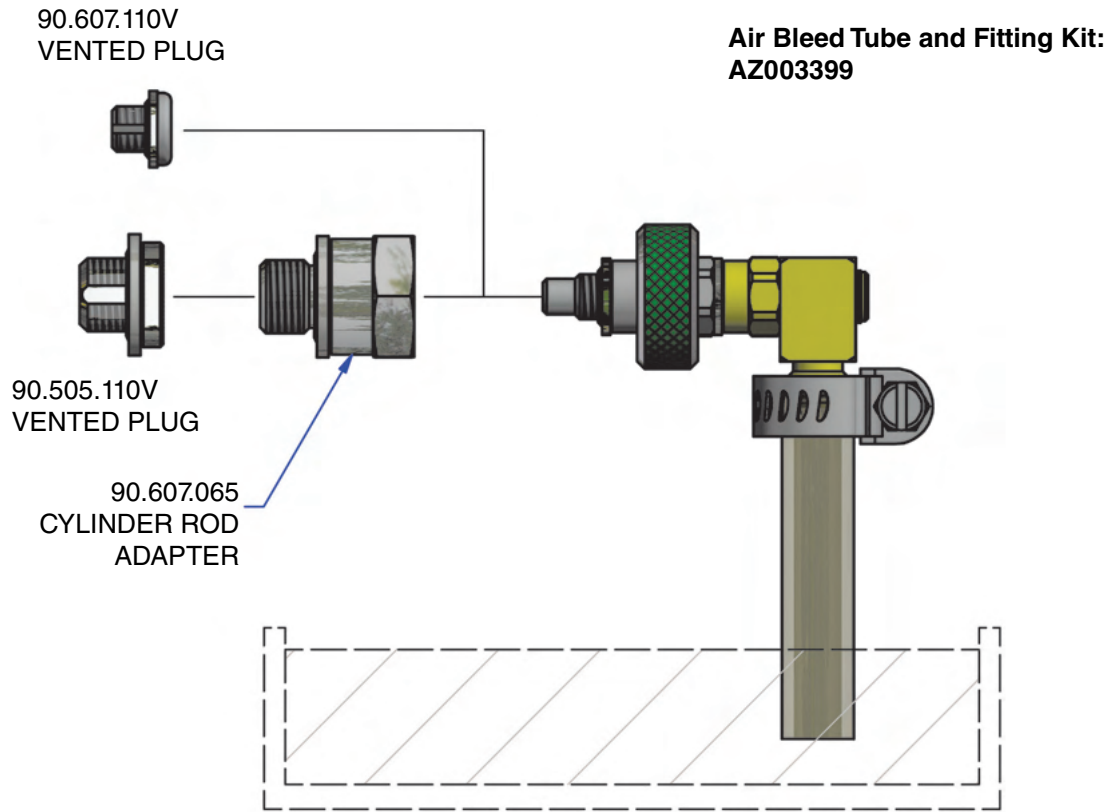

**NOT TO BE USED UNDER PRESSURE.
VENTING ONLY**

1. For oil filling, air bleed only.
2. Use knob torque only to fasten fitting.
3. Add oil until tube runs clear for 20 seconds.
4. Fill pump FP.FPA62 is included with DRS.FPA6.
5. Reinstall port plug after bleeding.

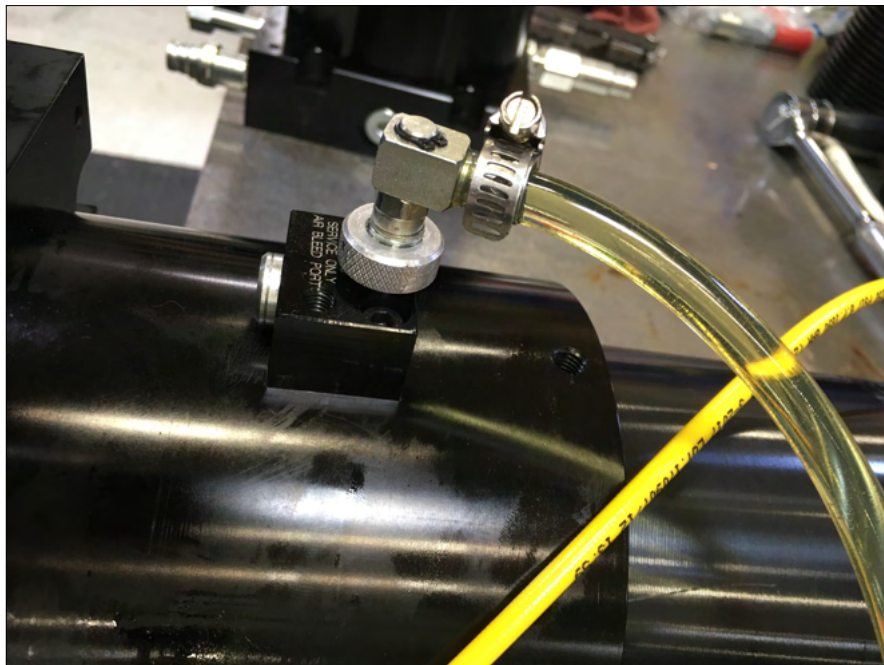

Filling and Venting System & Hydraulic Cylinder

DRS System Filling and Venting Illustration

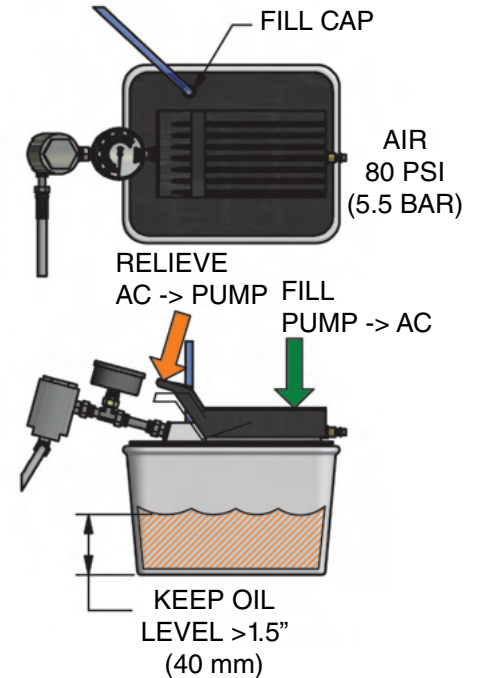
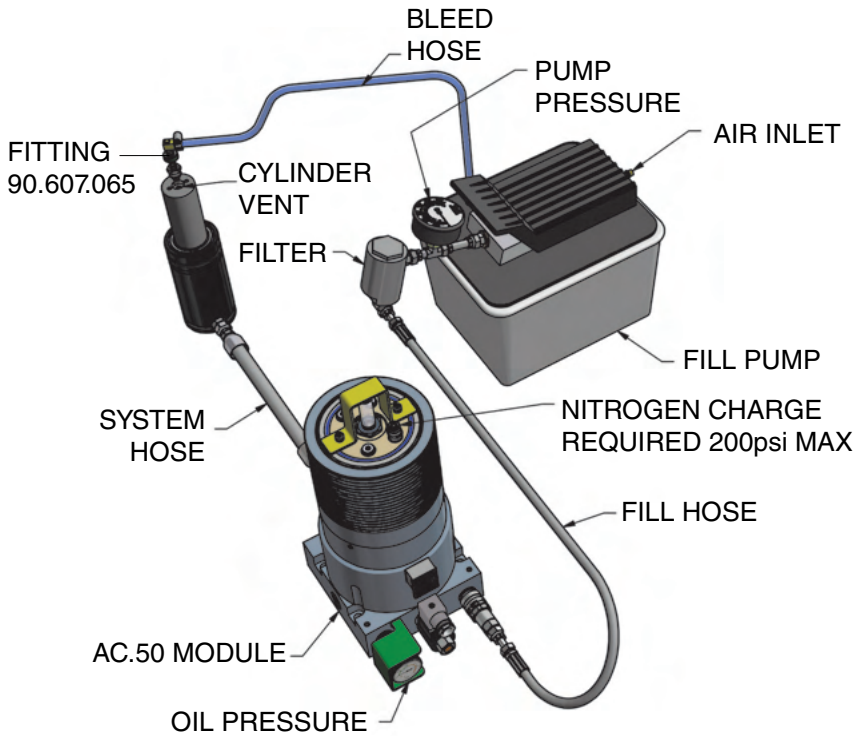

System Connection Set-Up

1. If AC.50 has a fan attached remove fan.
2. Remove bleed cover and M6 screw.
3. Attach M6 swivel into bleed port.
4. Couple fill hose onto Male fill coupler.
5. Attach nitrogen panel to nitrogen side.
6. Charge to low pressure <200psi, (14 bar).

Filling and Venting Illustration, Hydraulic Cylinder Only

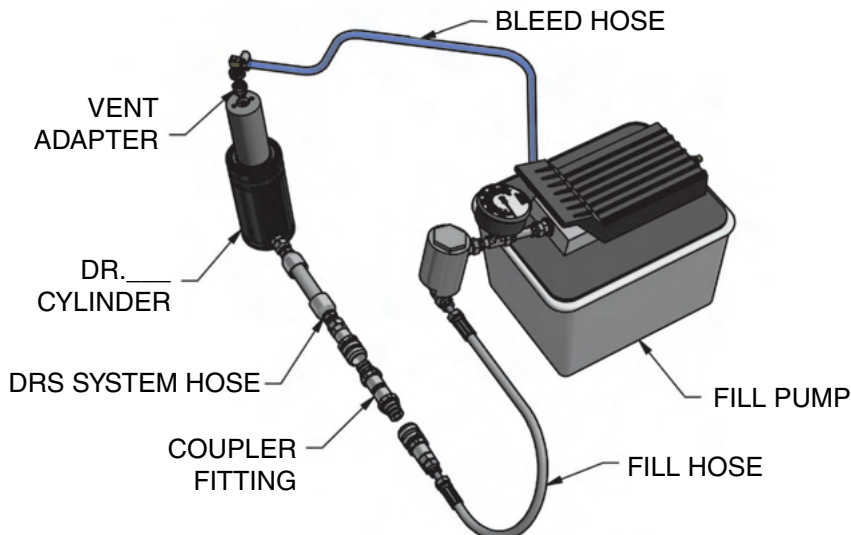

Venting Hydraulic Cylinder Alone

- Required if hydraulic cylinder is serviced or hose is replaced.
- Vent through rod end in common DR hydraulic cylinder types.
- Vent through base or side port in some models.
- Do not over pressurize hydraulic cylinder.
- When air purge is complete, cap hydraulic cylinder and check for compression.
- If "spongy" recheck for new air.
- DO NOT CYCLE IF NOT CONNECTED TO AC.50.
- HYDRAULIC CYLINDER DAMAGE WILL OCCUR IF OVER-PRESSURIZED.

Filling and Venting Illustration, AC.50 Accumulator

For best results remove AC.50 from tool and fill/bleed on bench or cart. The same steps may be followed as installed in the die, but the ability to bleed trapped air is reduced. If AC.50 cannot be removed from tool, pockets of air may remain.

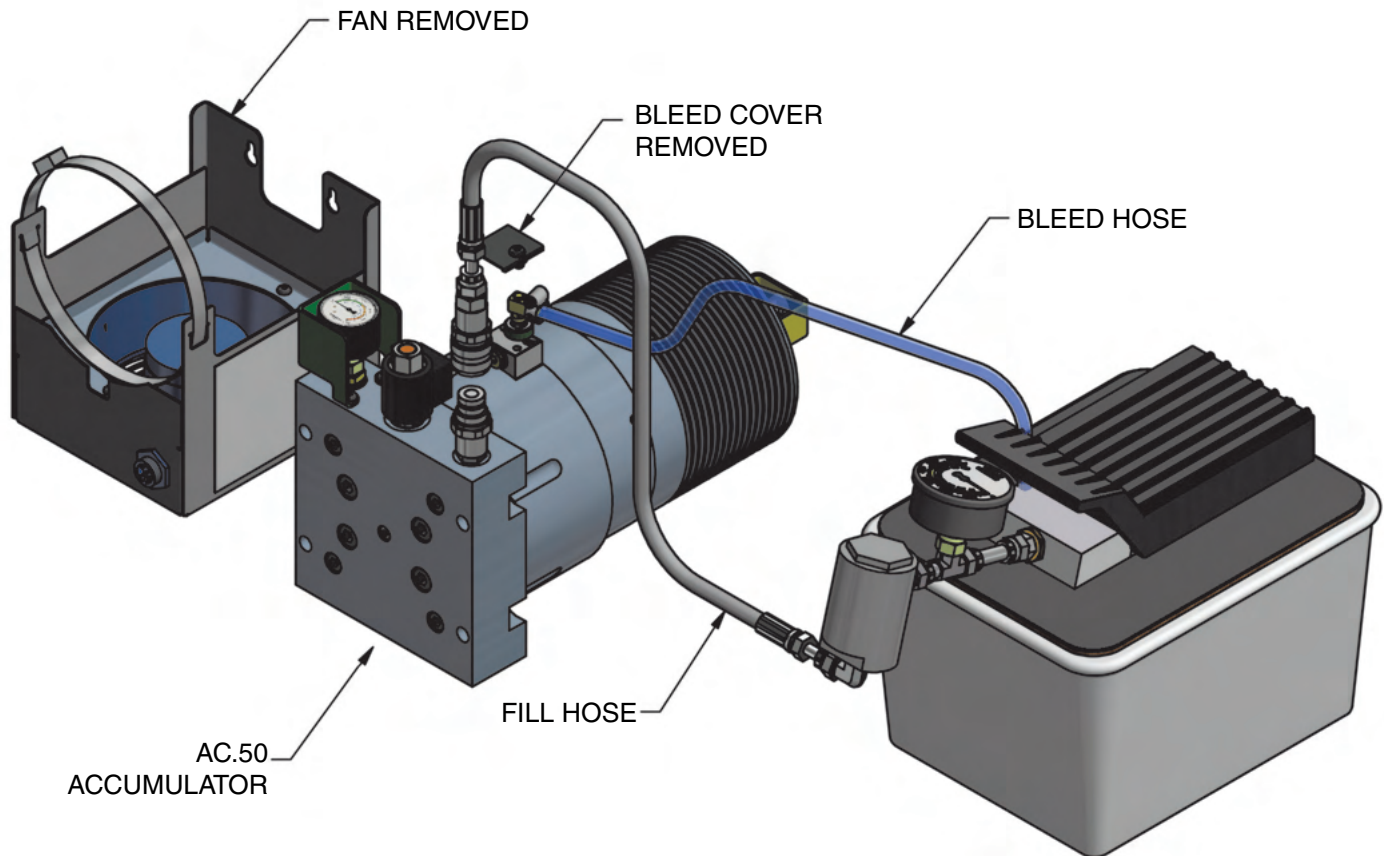

AC.50 Fan Removal

1. Disconnect power
2. Loosen two M6 screws on AC.50 top tail rod guard.
3. Loosen band clamp.
4. Slip fan off top of AC.50

Set Up Connections to AC.50

1. If AC.50 has a fan attached remove fan.
2. Remove bleed cover and M6 screw.
3. Attach M6 swivel into bleed port.
4. Couple fill hose onto Male fill coupler.
5. Attach nitrogen panel to nitrogen side.
6. Charge to low pressure <200psi, (14 bar).

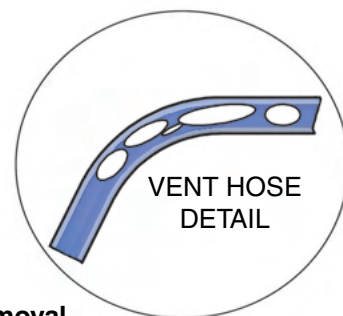
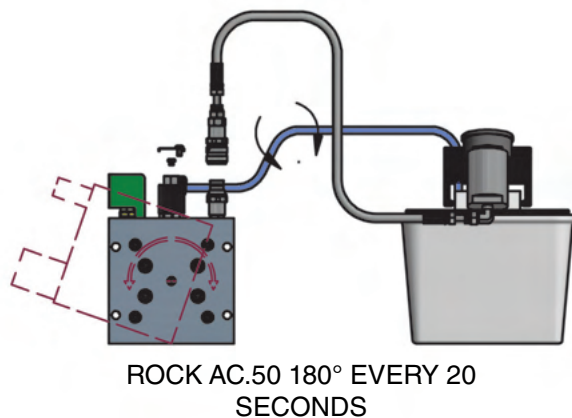

Determining Air Removal

1. Observe clear vent hose while filling.
2. Rotating or reorienting the AC.50 helps free air pockets.
3. Horizontal with vent up is best orientation.
4. When oil runs clear for ~ 20 second filling is ok.

**SBE (optional accessory) Off -
Before / After Delay Lockdown**



DO NOT OPEN
VENT PORT
SERVICE ONLY

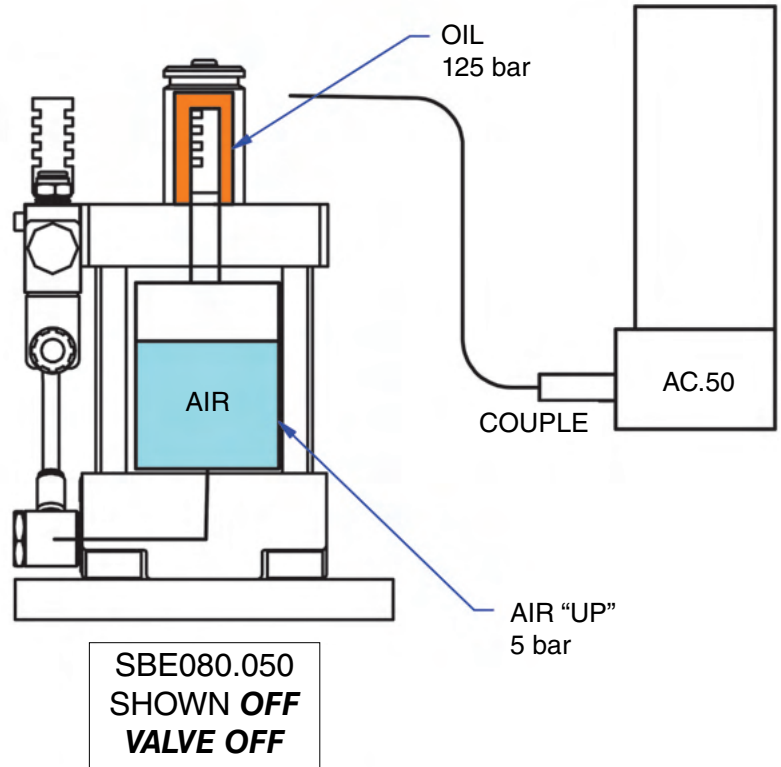
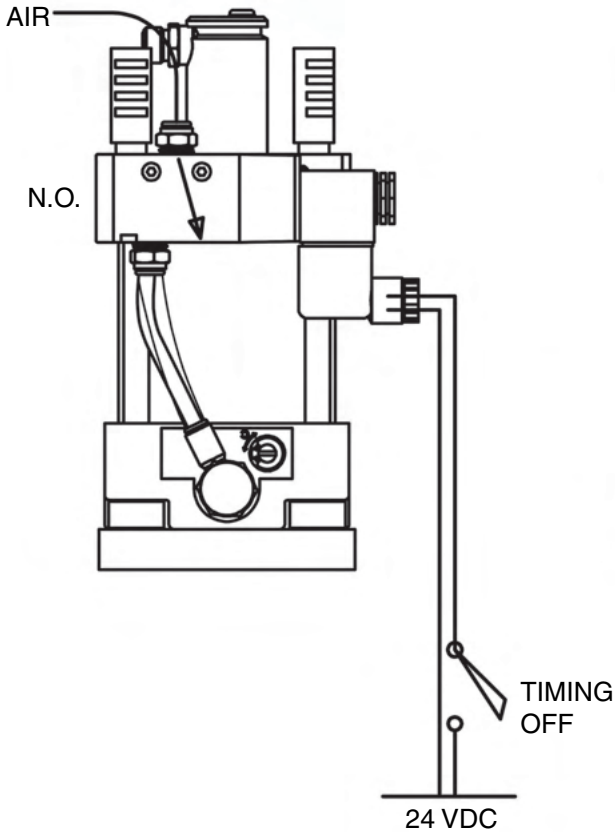

All components are pre-filled
DO NOT ADD EXTRA OIL

System Assembly

1. Connect hydraulic cylinders
2. Connect SBE to side port
3. Connect nitrogen panel
4. Connect AC.50 electrical 24 VDC
5. Connect SBE electrical .24 VDC
6. Connect air to SBE
7. Fill nitrogen

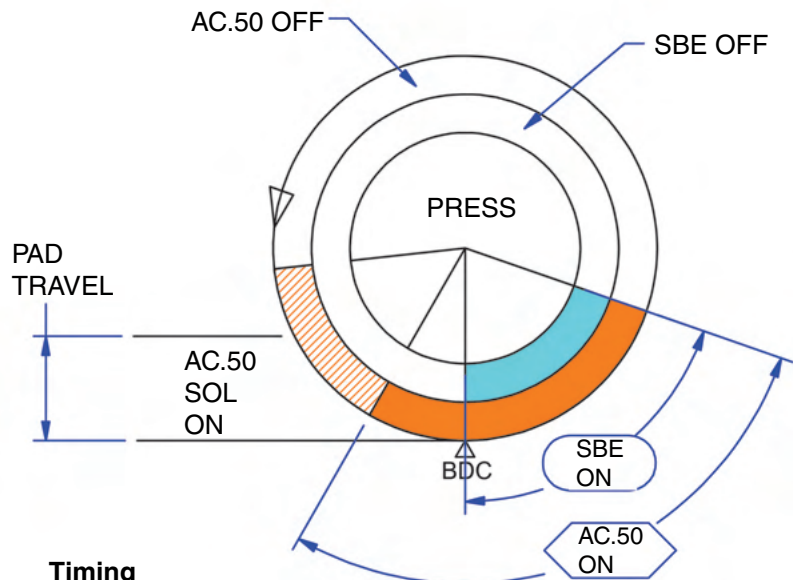

Timing

1. AC.50 **ON BEFORE** B.D.C
2. SBE **ON AT** B.D.C
3. AC.50 + SBE **OFF** after part is clear

SBE (optional accessory) Active - During Delay Lockdown

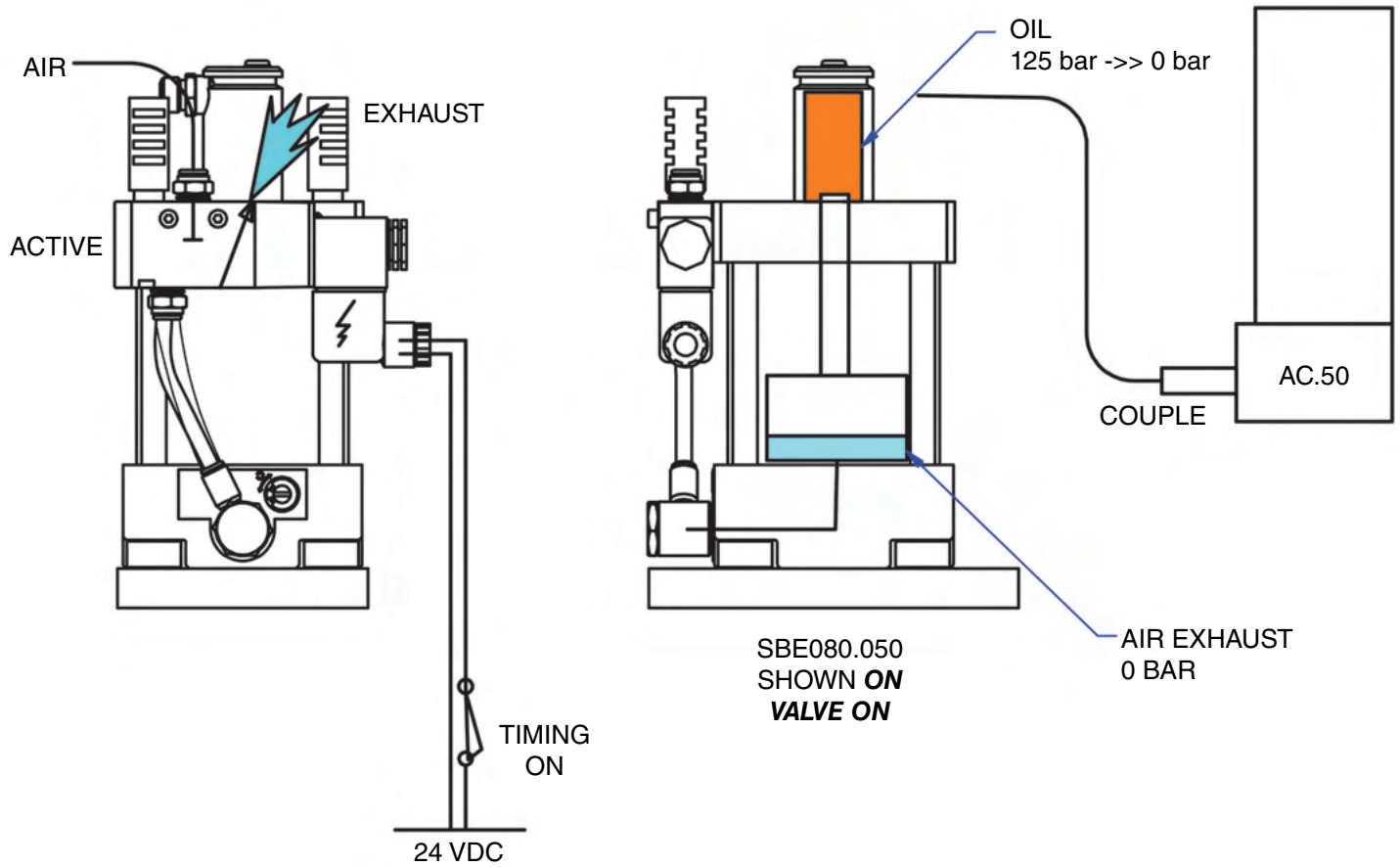

SBE Service Notes

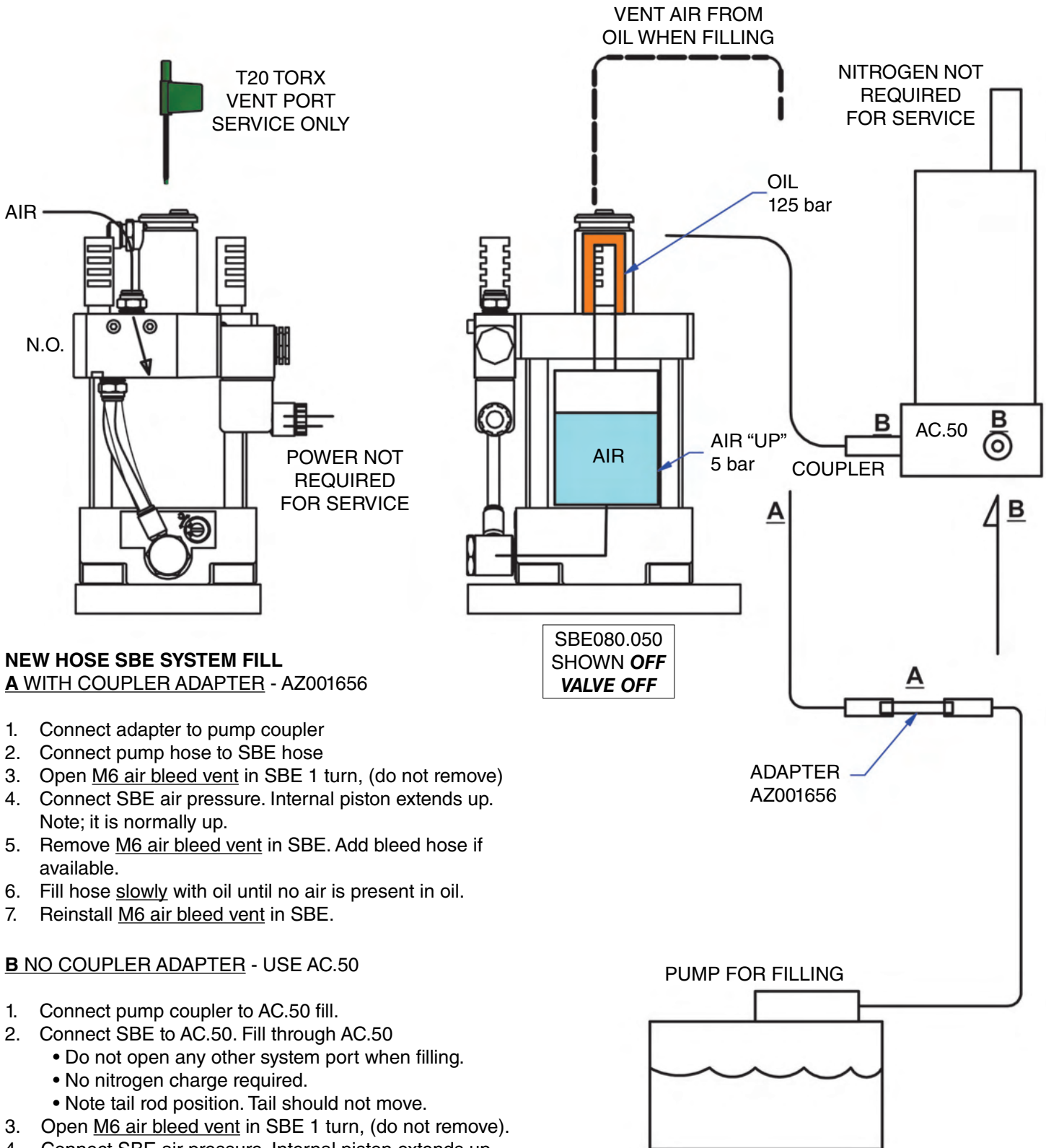

**NEW HOSE SBE SYSTEM FILL
A WITH COUPLER ADAPTER - AZ001656**

1. Connect adapter to pump coupler
2. Connect pump hose to SBE hose
3. Open M6 air bleed vent in SBE 1 turn, (do not remove)
4. Connect SBE air pressure. Internal piston extends up. Note; it is normally up.
5. Remove M6 air bleed vent in SBE. Add bleed hose if available.
6. Fill hose slowly with oil until no air is present in oil.
7. Reinstall M6 air bleed vent in SBE.

B NO COUPLER ADAPTER - USE AC.50

1. Connect pump coupler to AC.50 fill.
2. Connect SBE to AC.50. Fill through AC.50
 - Do not open any other system port when filling.
 - No nitrogen charge required.
 - Note tail rod position. Tail should not move.
3. Open M6 air bleed vent in SBE 1 turn, (do not remove).
4. Connect SBE air pressure. Internal piston extends up. Note; it is normally up.
5. Remove M6 air bleed vent in SBE. Add bleed hose if available.
6. Fill hose slowly with oil until no air is present in oil.
7. Reinstall M6 air bleed vent in SBE.

